



*An Online CPD Course
brought to you by
CEDengineering.ca*

Anti-Friction Bearings Fundamentals

Course No: M01-021

Credit: 1 PDH

Jon Russell

CEDE CANADA
engineering.ca
CPD FOR THE PROFESSIONAL

Continuing Education and Development, Inc.

P: (877) 322-5800

info@cedengineering.ca

www.cedengineering.ca

Anti-Friction Bearings Course



SAVRREE
3D INTERACTIVE MEDIA

Copyright © 2020 by saVRee UG (Haftungsbeschränkt)

All rights reserved. This publication or any portion thereof may not be reproduced or used in any manner whatsoever without the express written permission of the publisher.

First Edition, 2020 | saVRee UG | Schluderstrasse 2, Munich, 80634 Germany | www.savree.com | contact@savree.com

Anti-Friction Bearings Course

Course

Introduction	3
History	3
Bearing Functions.....	4
Friction	4
Loads	5
Guide Parts.....	6
Bearing Lubrication	6
Lubricant Types (mineral oil, synthetic, animal, plant).....	7
Components.....	7
Terminology	8
Alignment.....	8
Single and Double Row	9
Full Complement.....	10
Floating Bearings.....	10
Anti-Friction Bearing Types.....	10
Movement Types	10
Point and Line Contact	11
Tapered or Non-Tapered	11
Shields and Seals	12
Shields	12
Seals	12
Ball Bearings.....	13
Single and Double Row	13
Shallow and Deep Groove.....	14
Thrust Ball Bearings.....	14
Angular Contact Ball Bearings	14
Roller Bearings	15
Cylindrical Roller Bearings.....	15
Tapered Roller Bearings	16
Spherical Roller Bearings.....	17
Needle Roller Bearings.....	18
Bearing Comparison.....	18

Anti-Friction Bearings Course

Introduction

Bearings allow humans to move an object on, or within, another object. Their main purpose is to extract desired motion from a whole motion. For example, a pump shaft that passes through a pump housing should rotate, but the housing should not. Almost all machines operate with some form of rotating, sliding or oscillating motion, where this occurs, bearings are used.

There are **two** main categories of bearing, **plain** and **anti-friction (rolling)**. Both bearing designs have found widespread application throughout the engineering world, but no single bearing design can cater for all applications. As can be seen on the below images, the two types of bearing are not even slightly similar. **This course focuses on anti-friction bearings only.**



Anti-Friction Bearing

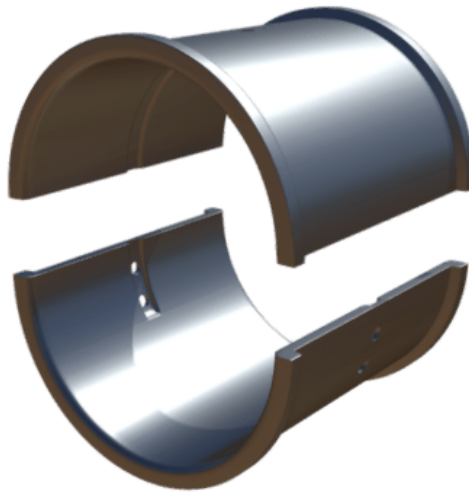

Plain Bearing

History

Bearings date back to the age of antiquity and have existed in various forms over the past several thousand years. The earliest recorded plain bearing design (very basic) originates from Egyptian times, whilst the oldest recovered rolling element bearing design dates back to 40 BC.

Leonardo da Vinci drew concepts of the modern-day ball bearing in circa. 1500 and Galileo developed this design still further in the 1700s. It was not until 1740 that John Harrison invented a practical caged roller bearing, and it would be a further 54 years until Philip Vaughan patented the first modern ball bearing design (1794).

Anti-Friction Bearings Course

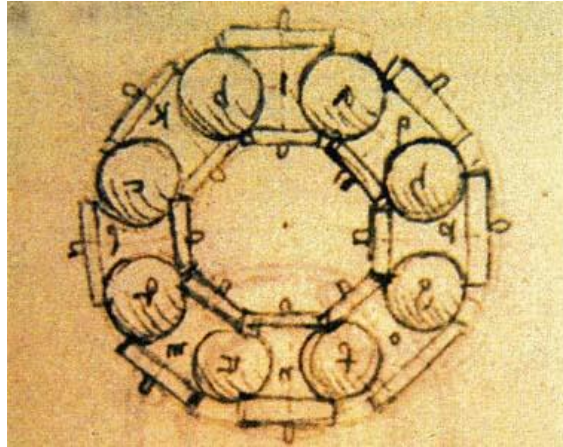

Leonardo da Vinci Ball Bearing

The industrial revolution in the 1800s saw a massive increase in the design and application of bearings. As the applications of bearings grew, so did the range of materials they were constructed from. Bearings were constructed from sapphire, wood, ceramic, metal and glass (to name a few materials). Some of the largest bearing companies in existence were founded during this period, these include **FAG** (1883), **Timken** (1898) and **SKF** (1907).

Many additional advances in bearing technology have continued over the past 100 years although most developments have refined existing bearing designs rather than created entirely new ones.

Bearing Functions

All bearings have **three** main functions:

- **Reduce Friction**
- **Carry Load**
- **Guide Parts**

This section of the course discusses each of these topics in greater detail.

Friction

Friction is the resistance to movement between two or more bodies. Friction has several forms, but the most relevant concerning bearings are **static**, **sliding** and **rolling** friction. Note that sliding and rolling friction are also sometimes referred to as **dynamic** forms of friction.

Static friction – friction between two (or more) solid bodies that are **not** moving relative to each other. Any force applied to a body must overcome static friction before it begins to move. For example, a box placed stationary on a table will not move unless the force applied exceeds static friction.

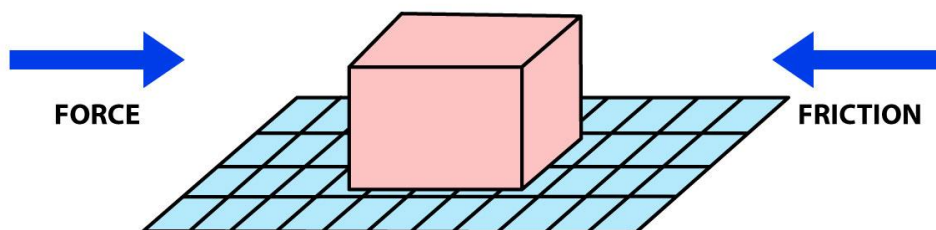

Static Friction Holding a Box Stationary

Sliding friction – friction between two bodies that are moving relative to each other and in contact with each other. For example, a box being sild across a table. Sliding friction is also known as **dynamic** or **kinetic** friction.

Anti-Friction Bearings Course

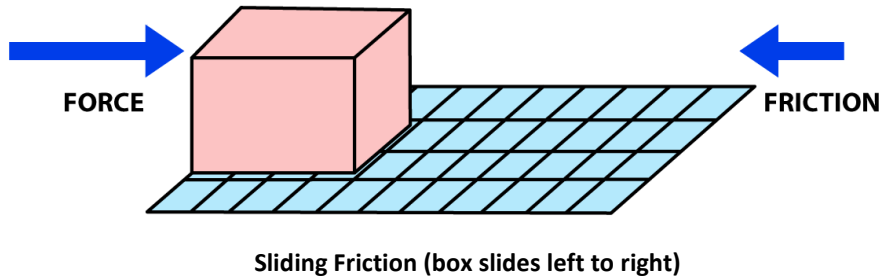

Rolling friction – friction between two bodies when one rolls across another. For example, when a car wheel rolls across a road. Rolling friction is usually less than sliding friction.

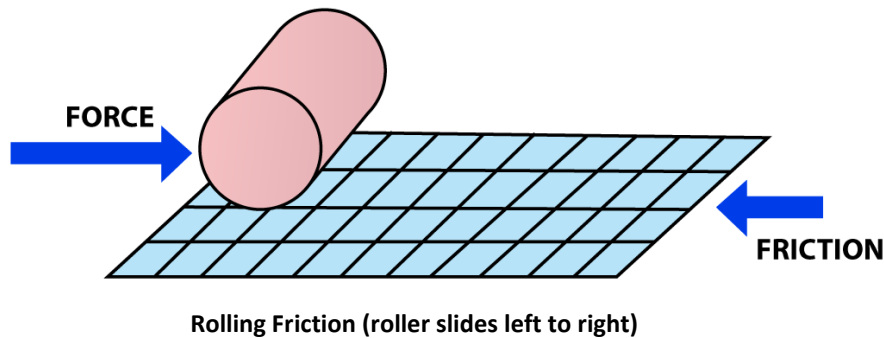

Plain bearings operate on the principle of sliding friction whilst rolling (anti-friction) bearings operate on the principle of rolling friction. The co-efficient of friction associated with rolling bearings is usually lower than that of plain bearings.

Loads

Bearings are expected to carry loads during their working life. Loads may be **axial**, **radial** or **combined**. Bearings must be selected based upon the loads and service conditions they are likely to encounter. Incorrect sizing and selection of a bearing may lead to bearing failure.

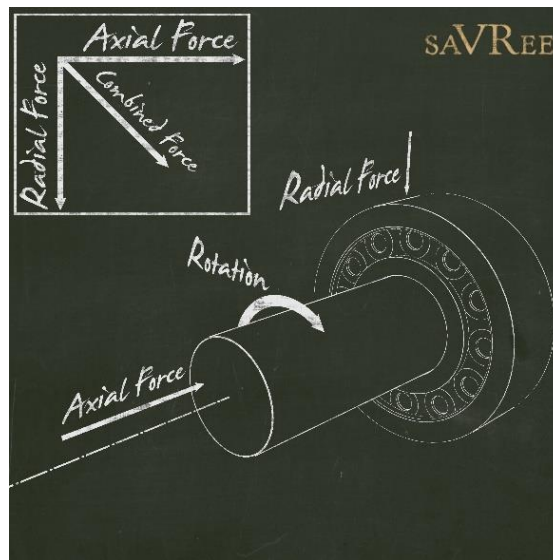

Bearing Loads

Axial loads – loads which are applied **parallel** to the shaft; sometimes called **thrust** loads.

Radial loads – loads which are applied **perpendicular** (90 degrees) to the shaft.

Combination loads – loads which are a **combination of both axial and radial loads**; sometimes referred to as **angular loads**.

Anti-Friction Bearings Course

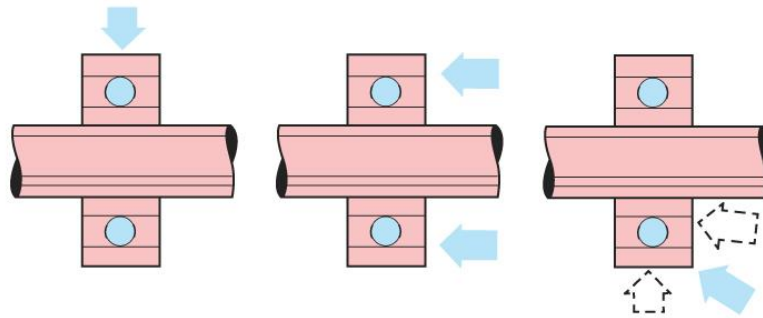

Radial, Axial and Combination Loads

Bearings are designed to cater for specific load conditions. For example, **deep groove ball bearings** can carry moderate to heavy radial loads and some axial loads, this makes them suitable for many applications. The deep groove ball bearing is the most common anti-friction bearing in use today.



Deep Groove Ball Bearing (exploded view)

Guide Parts

Guiding of parts usually refers to machinery components having a sliding or reciprocating motion. A bearing by nature guides parts because it **confines unwanted motion and allows desirable motion**. For example, it is desirable that motion is transmitted to the wheels of a car so that they rotate, but it is not desired that this motion be transferred to the engine casing.

Bearing Lubrication

All anti-friction bearings require some form of **lubrication**. The most common forms of lubrication are **liquid lubricants** (mineral oil etc.) and **grease** (lubricant mixed with a thickening agent). Appropriate lubricants will:

- **Reduce friction**, which **reduces heat and wear**.
- **Protect** bearing surfaces from **corrosion** and **foreign particle contamination**.
- **Dissipate heat**.

Typical **anti-friction bearing lubricants** include mineral oil, various greases, animal fats and vegetable-based oils (to name a few).

Anti-Friction Bearings Course

Lubricant Types (mineral oil, synthetic, animal, plant)

Mineral oil-based lubricants are by far the most popular lubricant because they are cheap and versatile.



Mineral Oil Lubrication

Synthetic lubricants generally cost much more than mineral oil-based lubricants and are not as common.

Animal fat-based lubricants are not viable for many applications due to their low availability compared to other lubricant types. An additional problem with animal fats is that some religions do not allow for the handling of certain animal fats e.g. swine/pig fat.

Plant/vegetable oils are growing in popularity due to recent advances in technology which are reducing production costs. The largest advantage with this type of lubricant is that it is **biodegradable**.

Components

The subject of anti-friction bearings is made more difficult due to the varying terminology that is used to describe identical parts. The below table lists bearing components along with additional common colloquial names.

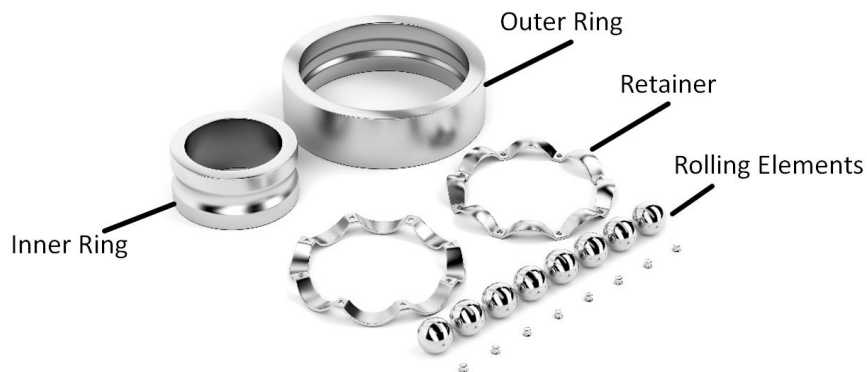

Anti-Friction Bearing Components

Anti-Friction Bearings Course

Name	Also known as...	Also known as...	Notes
Anti-Friction Bearing	Rolling Bearing	Rolling Element Bearing	Known as rolling bearings, rolling contact bearings and rolling element bearings.
Rolling Elements			Rolling elements are of the ball or roller type.
Race	Ring		Rolling elements are usually held between two bearing races, an <i>inner race</i> and an <i>outer race</i> . When only the outer race is present, the shaft will act as the inner race.
Raceway			Grooves within the inner and outer rings form the raceway. Rolling elements roll within the raceway.
Cage	Retainer	Separator	The cage spaces the rolling elements apart from each other.
Inner Ring	Inner Race	Cone	Forms the inner part of an anti-friction bearing (the part that presses against the shaft). The inner ring usually rotates with the shaft. The term 'cone' is usually reserved for tapered bearings only, although many publications make no distinction between the inner ring/race and cone.
Outer Ring	Outer Race	Cup	Forms the outer part of an anti-friction bearing. The outer ring does not usually rotate with the shaft. The term 'cup' is usually reserved for tapered bearings only, although many publications make no distinction between the outer ring/race and cup.

Terminology

Some familiarity with common terms such as *alignment*, *single row*, *double row* and *bearing complement*, is needed before a brief overview of each type of anti-friction bearing type is given. This section discusses some common terminology that is used to describe various bearing operational aspects and designs.

Alignment

Alignment is critical if a bearing is to function correctly without failure. Misalignment can be either **static** or **dynamic**.

Static – misalignment due to incorrect bearing mounting.

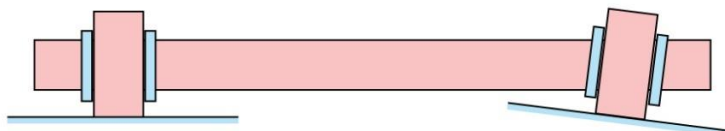

Static Misalignment (incorrect mounting)

Anti-Friction Bearings Course

Dynamic – misalignment due to operating conditions e.g. thermal expansion.

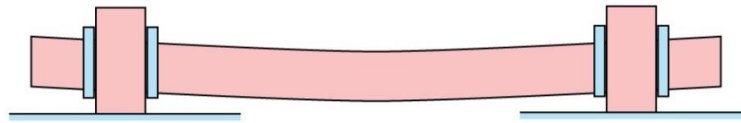

Dynamic Misalignment (bent shaft)

Bearing misalignment is measured in degrees. Some bearings have a high tolerance for misalignment whilst others have almost no tolerance for misalignment.

Single and Double Row

Anti-friction bearings are commonly **single row**, or **double row**, although they can also have more than two rows.

A **single row** bearing contains only **one row** of rolling elements.



Single Row Anti-Friction Bearing

A **double row** bearing contains **two rows** of rolling elements.



Double Row Anti-Friction Bearing

Double row bearings are often employed to handle loads acting in opposing directions, or, to increase the load contact surface area of the bearing and thus the overall load carrying ability of the bearing.

Anti-Friction Bearings Course

Full Complement

Anti-friction bearings may have their cage removed to maximise the number of rolling elements carried by the bearing. A bearing that has no cage, is referred to as a '**full complement**' bearing. Full complement bearings can carry higher loads due to the larger load carrying contact area of the rolling elements, but they can only be used for slower speed applications (due to the additional friction created by the additional rolling elements).

Floating Bearings

Floating bearings allow for some form of axial movement. **Fixed bearings do not** allow for axial movement. Most installations use a single fixed bearing and one or more floating bearings. Floating bearing arrangements are needed to accommodate thermal expansion and contraction of parts, and misalignment. Floating bearings are commonly installed with self-aligning bearings.

Anti-Friction Bearing Types

Anti-friction bearings are classified as either **ball** or **roller** types. Ball bearings use sphere shaped rolling elements whilst roller bearings use non-sphere-shaped rolling elements.

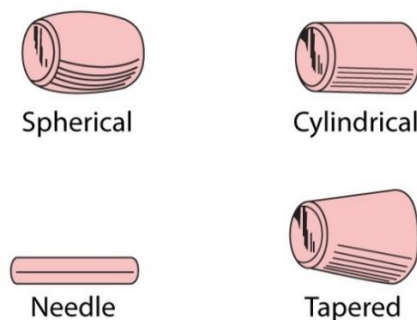

Roller Bearing Elements

Movement Types

Anti-friction bearing movement types are:

- **Rotation about a point.**
- **Rotation about a line.**

About-A-Point

A ball rotates **about a point** (the centre of the ball). Bearings that use balls that rotate about a point generate a low amount of friction and are suitable for moderate to high speed applications.

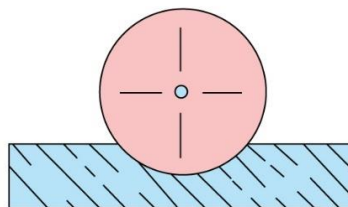

Centre Point of a Ball

About-A-line

A **roller bearing** rotates **about a line**. Bearings that rotate about a line are capable of handling higher loads than about a point type bearings, but generate more friction and consequently operate at lower speeds.

Anti-Friction Bearings Course

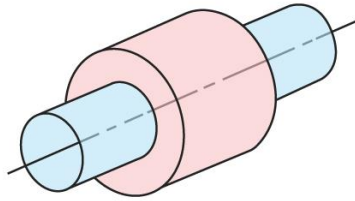

Mounted Plain Bearing

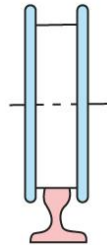

Railway Wheel on Tracks

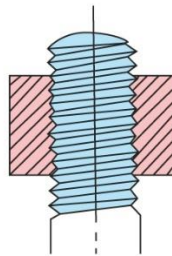

Screw Thread

Point and Line Contact

Ball bearings operate upon the principle of **point contact**. Only a small amount (a point) of each ball is in contact with a raceway at any given time.

Roller bearings operate upon the principle of **line contact**. The contact surface area between the rolling elements and raceways is much greater than for ball rolling elements, and so is the amount of friction generated.

Tapered or Non-Tapered

Roller type anti-friction bearings are classified as either **tapered** or **non-tapered**.

Tapered roller bearings have races and rolling elements that slant inwards towards a central point (**apex**) along the **bearing axis** (an imaginary horizontal line that runs directly through the bearing's centre). Non-tapered roller bearings have races and rolling elements that align parallel with the bearing axis.

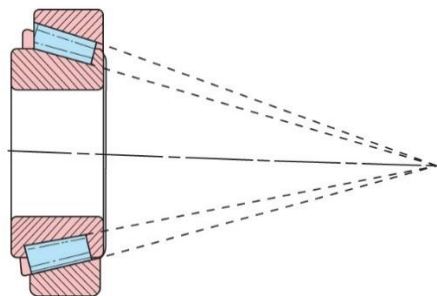

Tapered Anti-Friction Bearing

Anti-Friction Bearings Course

Shields and Seals

Anti-friction bearings may be **open**, **shielded** or **sealed**. A bearing without either a shield or seal, is an open bearing. Open bearings must be lubricated whilst in service, whilst shielded and sealed bearings can be pre-lubricated (filled with grease) and '**sealed for life**'.

Bearings with a shield or seal have a different appearance to open bearings because the rolling elements of the bearing cannot be seen.



Sealed Anti-Friction Bearing

Shields

Shields prevent foreign particle ingress and are attached to the stationary race only. Shields offer some form of protection against particle ingress, but no protection against water ingress. Shields can be one of two types, '**pressed-in**' (typically designed to be non-removable) and '**removable**'.

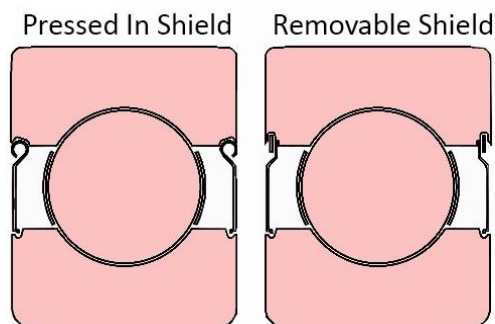

Shield Types

Seals

Seals prevent lubricant from exiting the bearing whilst also preventing moisture and foreign particle ingress. Unlike shields, a seal may press against one ring (**non-contact seal**), or both rings (**contact seal**). Contact type seals are suitable only for lower speed ranges due to the additional friction and heat created by the seal.

Seals are usually constructed of **rubber** or **Teflon**; rubber is not suitable for high temperature applications.

On most designs, it is possible to replace/renew the seal.

Anti-Friction Bearings Course

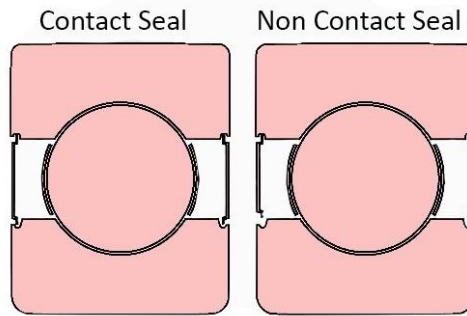

Seal Types

Ball Bearings

Ball bearings are probably the most widely known and easiest to identify. This type of bearing operates upon point contact with one stationary ring (usually the outer ring) and one rotating ring.

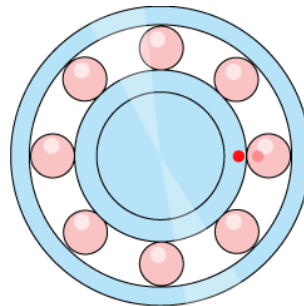

Anti-Friction Ball Bearing

Common ball bearing designs include **single row**, **double row**, **thrust** and **angular contact**. Each design of ball bearing caters for the different loads it is likely to encounter.

Single and Double Row

Single row ball bearings are incredibly versatile, they can be used for medium-high radial loads and light thrust loads, in either direction. It is possible to have a **maximum capacity** bearing that contains more rolling elements, this increases the radial load the bearing can carry but reduces its axial load carrying capacity.

Double row ball bearings can carry more radial load than their single row counterparts but are wider. This type of bearing can support heavy radial loads and low-medium axial loads, in either direction.



Double Row Ball Bearings

Anti-Friction Bearings Course

Shallow and Deep Groove

Ball bearings may be **shallow groove** or **deep groove**. The 'groove' is the depth of the raceway into which the balls fit. Deep groove single row ball bearings are also known as **Conrad** bearings. Deep groove ball bearings can carry higher radial and axial loads than shallow groove ball bearings counterparts.

Thrust Ball Bearings

Thrust ball bearings are designed to accommodate axial loads only and **cannot** support radial loads. They may be installed individually, or in pairs. Thrust ball bearings are ill suited to high speed applications due to the heavy loading that occurs at the outer edges of the races. A common application of thrust ball bearings is the clutch release in an automobile.

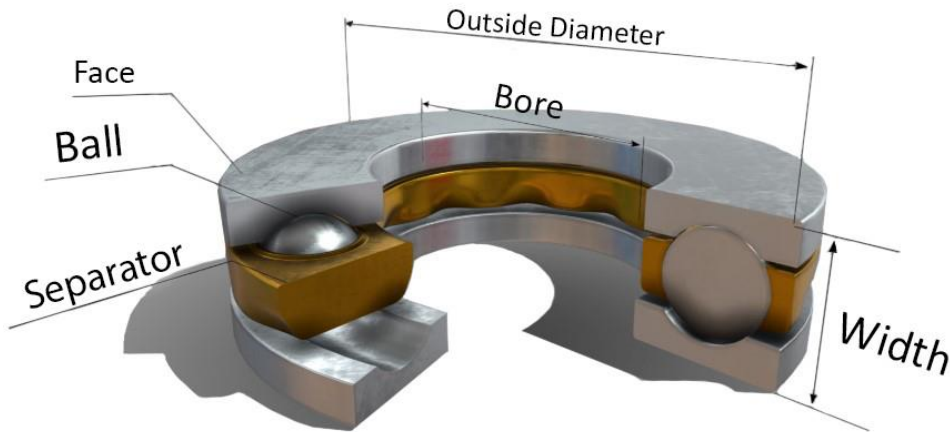

Thrust Ball Bearing Cross Section

Angular Contact Ball Bearings

Anti-friction ball bearings can be used to accommodate radial loads and high thrust loads, where this occurs, an **angular contact** ball bearing design is used. Angular contact bearings utilise two high shoulders, one on the inner ring and one on the outer ring, this increases its axial load carrying capacity. This type of bearing handles thrust in only one direction.

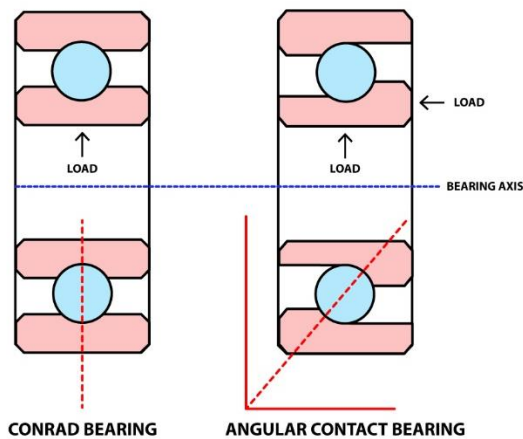

Bearing Comparison

Anti-Friction Bearings Course

Roller Bearings

There are **four** main types of **roller bearing** and each is named after the rolling elements they use.

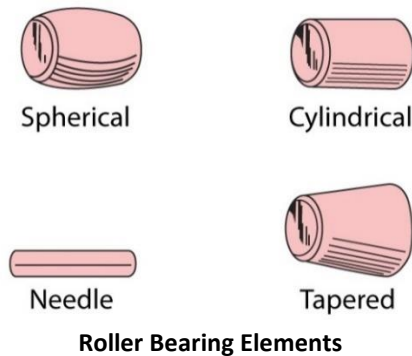

All roller bearings operate using **line contact** and can carry significantly higher radial loads than ball bearings; most roller bearings are poorly suited to handle axial loads.

Roller bearings have higher coefficients of friction than ball bearings and are consequently not suitable for very high-speed applications. Roller bearings **do not** use the term *angular contact* or *angular load*.

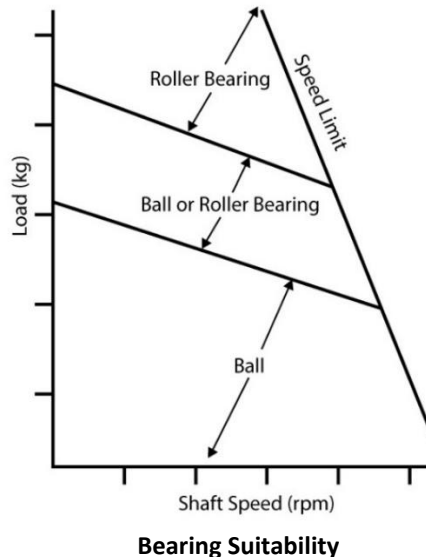

Cylindrical Roller Bearings

Cylindrical roller bearings consist of an outer ring, inner ring, cage and rollers. The cylindrical rollers (rolling elements) may be either solid or hollow. The diameter of each cylinder is not much smaller than the length of each cylinder, this prevents the bearings skewing under load.

Cylindrical roller bearings can carry high radial loads but they are not well suited to handling axial loads.



Cylindrical Roller Bearing

Anti-Friction Bearings Course

Tapered Roller Bearings

Tapered anti-friction roller bearings are used for heavy radial and axial (thrust) loads. This type of bearing is used extensively in the automotive industry. Unlike non-tapered roller bearings, tapered roller bearings have races and rolling elements that slant inwards towards a central point along the bearing axis (**apex**). If all rolling elements were extended, they would intersect at the central point and **true rolling** would occur (the rolling elements would roll against each other).

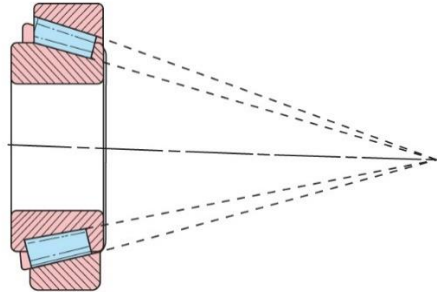

Tapered Anti-Friction Bearing

Tapered roller bearings consist of a cup, cone, retainer and rolling elements. The cup shaped design allows each rolling element to align itself perfectly between the cup and cone; this ensures the load is spread evenly across all of the rolling elements.

Unlike other bearing designs, the cup and cone can be separated. This means it is possible to mount the cone and rolling elements first, then the cup.

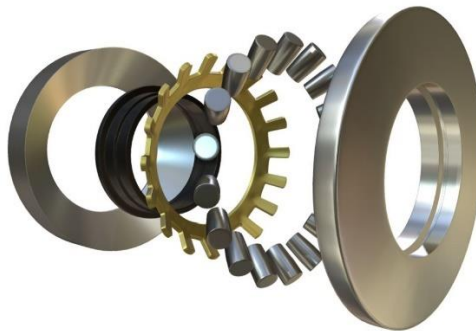

Tapered Bearing (exploded view)

Tapered roller bearings are often mounted in pairs ('back-to-back') to handle increased radial loads and axial loads in both directions.

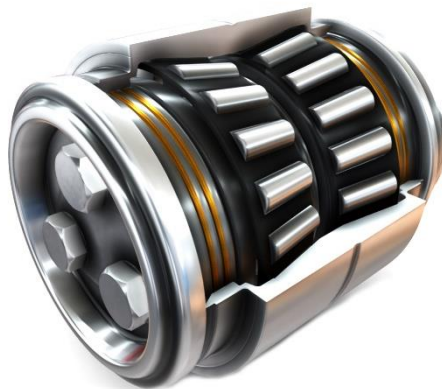

Mounted Tapered Bearings

Anti-Friction Bearings Course

Spherical Roller Bearings

Spherical roller anti-friction bearings can carry high radial and moderate-high axial loads; they are often of the single or double row design. This type of bearings gets its name from the spherical shape of the groove on the outer ring.

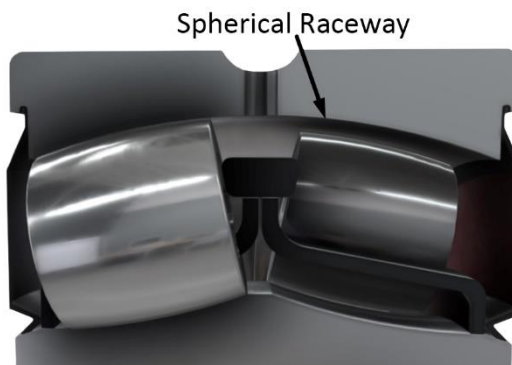

Spherical Roller Bearing Cross Section

Rolling elements are **barrel** shaped.



Spherical Roller Bearing (barrel shaped rolling elements)

Spherical roller bearings can handle misalignment much better than other roller bearing designs and are the bearing of choice if misalignment is a normal operating condition. Modern spherical roller bearings can handle **one to two degrees** of misalignment.

Anti-Friction Bearings Course

Needle Roller Bearings

Needle roller bearings are similar to cylindrical roller bearings, but the rolling elements have a longer length to diameter ratio (**typically 4:1 or more**). This type of bearing is typically used where space for a standard cylindrical roller bearing is not available.



Needle Bearing (not full complement)

Needle roller bearings can carry high radial loads due to the large contact area of the rolling elements; they are not designed to carry axial loads.

Some needle bearings are equipped with an inner race, but some have no inner race. In cases where no inner race is present, the shaft forms the inner race. Shafts are often manufactured from hardened materials if they act as an inner race; the hardened material is less prone to wear which leads to a longer service life for the shaft.

Full complement type needle roller bearings have no retainer and are used for slow speed, high load applications.

Bearing Comparison

Important: The below table is very general, there are dozens of variations of bearings and small modifications sometimes make large differences to a bearing's load and speed capabilities.

Type	Sub-Category 1	Sub-Category 2	Radial Load	Axial Load	Speed	Notes
Anti-Friction	Ball	Shallow Groove	Low	Low	Moderate-High	
		Deep Groove	Moderate	Low	Moderate-High	Also known as a Conrad bearing.
		Thrust	Zero	High	Low-Moderate	High speed application causes edge loading on races.

Anti-Friction Bearings Course

Type	Sub-Category 1	Sub-Category 2	Radial Load	Axial Load	Speed	Notes
Anti-Friction	Roller	Cylindrical	Moderate-High	Very Low	Low-Moderate	Larger contact area allows for higher radial loads, but at lower speeds.
		Needle	Moderate-High	Very Low	Low-Moderate	Smaller diameter bearing with a longer length. Lower speeds than cylindrical bearing. Comes with or without inner race.
		Spherical (Barrel)	Moderate-High	Medium-High	Low-Moderate	Ideal for misalignment applications.
		Tapered	Moderate-High	Low-Medium	Low-Moderate	Cup and cone can be installed separately.

Suitability of rolling bearings for industrial applications

APPENDIX-1

Symbols		Load carrying capability			Misalignment		Arrangement				Suitable for					Design features			
		Radial load	Axial load	Moment load	Static misalignment	Dynamic misalignment (few tenths of a degree)	Locating	Non-locating	Adjusted	Floating	Long grease life	High speed	Low run-out	High stiffness	Low friction	Integral sealing	Separable ring mounting	Tapered bore	Standard housings and accessories available
+++ excellent ++ good + fair - poor -- unsuitable	↔ double direction ← single direction □ non-locating displacement on the seat ■ non-locating displacement within the bearing ✓ yes ✗ no																		
Bearing type																			
Deep groove ball bearings		+	++↔	A-, B+	-	--	↔	□	✗	✓	A+++ B++	A+++ B+	A+++ B++	+	+++	A✓	✗	✗	✗
Insert bearings		+	++↔	--	++	--	↔	↔	✗	✗	+++	++	A, B+ C++	+	++	✓	✗	✗	✓
Angular contact ball bearings, single row		+1)	++←	--	-	--	✗	✗	✓	✗	++	++	+++	++	++	✓	✗	✗	✗
matched single row		A, B++ C+++1)	A, B+++↔ C++←	A++, B+ C--	A, C--, B-	--	A, B↔ C←	A, B□ C✗	✗	✗	++	++	+++	++	++	✗	✗	✗	✗
double row		++	++↔	++	--	--	↔	□	✗	✗	++	++	++	++	++	A✓	B✓	✗	✗
four-point contact		+1)	++↔	--	--	--	↔1)	--	--	--	+	+++	++	++	++	✗	✓	✗	✗
Self-aligning ball bearings		+	-	--	+++	+2)	↔	□	✗	✓	+++	++	++	+	+++	✓	✗	✓	✓
Cylindrical roller bearings, with cage		++	--	--	-	--	✗	■	✗	✗	++	+++	+++	++	+++	✗	✓	✗	✗
		++	A, B+← C, D+↔	--	-	--	A, B← C, D↔	A, B■← C, D✗	✗	A✓ B, C, D✗	+++3)	+++	++	++	+++	✗	✓	✗	✗
full complement, single row		+++	+←	--	-	--	←	A, B←	✗	✓	-	+	+	+++	-	✗	A✗ B✓	✗	✗
full complement, double row		+++	A--, B+← C+↔	--	-	--	B← C, D↔	A■↔ B■←	✗	✗	-	+	+	+++	-	D✓	✗	✗	✗
Needle roller bearings, with steel rings		++	--	--	A, B- C++	--	✗	■↔	✗	✗	++	++	+	++	+	A✓	✓	✗	✗
assemblies / drawn cups		++	A, B-- C-	--	-	--	A, B✗ C←	A, B■ C■←	✗	✗	++	++	+	++	+	B, C✓	✓	✗	✗
combined bearings		++	A-, B+ C++	--	--	--	←	✗	✓	✗	+	+	+	++	+	✗	✓	✗	✗
Tapered roller bearings, single row		+++1)	++←	--	-	--	←	✗	✓	✗	+	++	+++	++	+	✗	✓	✗	✗
matched single row		A, B+++ C+++1)	A, B+++↔ C++←	A+, B++ C--	A-, B-, C--	--	A, B↔ C←	A, B□ C✗	A, B✗ C✓	✗	+	+	++	+++	+	✗	✓	✗	✗
double row		+++	++↔	A+ B++	A-, B--	--	↔	□	✗	✗	+	+	++	+++	+	✓	✓	B✓	✗
Spherical roller bearings		+++	+↔	--	+++	+2)	↔	□	✗	✓	+	++	+++	++	+	✓	✗	✓	✓
CARB toroidal roller bearings, with cage		+++	--	-	++	-	✗	■	✗	✗	+	++	+++	++	+	✗	✗	✓	✓
full complement		+++	--	-	++	-	✗	■	✗	✗	-	+	+++	++	-	✓	✗	✓	✓
Thrust ball bearings		--	A+← B+↔	--	--	--	A← B↔	✗	✗	✗	+	-	++	+	+	✗	✓	✗	✗
with sphered housing washer		--	A+← B+↔	--	++	--	A← B↔	✗	✗	✗	+	-	+	+	+	✗	✓	✗	✗
Cylindrical roller thrust bearings		--	++←	--	--	--	←	✗	✗	✗	-	-	+	+++	+	✗	✓	✗	✗
Needle roller thrust bearings		--	++←	--	--	--	←	✗	✗	✗	-	-	+	+++	+	✗	✓	✗	✗
Spherical roller thrust bearings		+1)	+++←	--	+++	+2)	←	✗	✓	✗	-	+	+	+++	+	✗	✓	✗	✗

1) Provided the F_d/F_r ratio requirement is met 2) Reduced misalignment angle – contact SKF 3) Depending on cage and axial load level